

How to make a land yacht

You will need:

- Scissors
- A sheet of polystyrene
- Cardboard
- Four pins
- Four small beads (optional)
- Pen/pencil
- A €2 coin or a compass
- A lolly stick
- Sticky tape
- A piece of paper

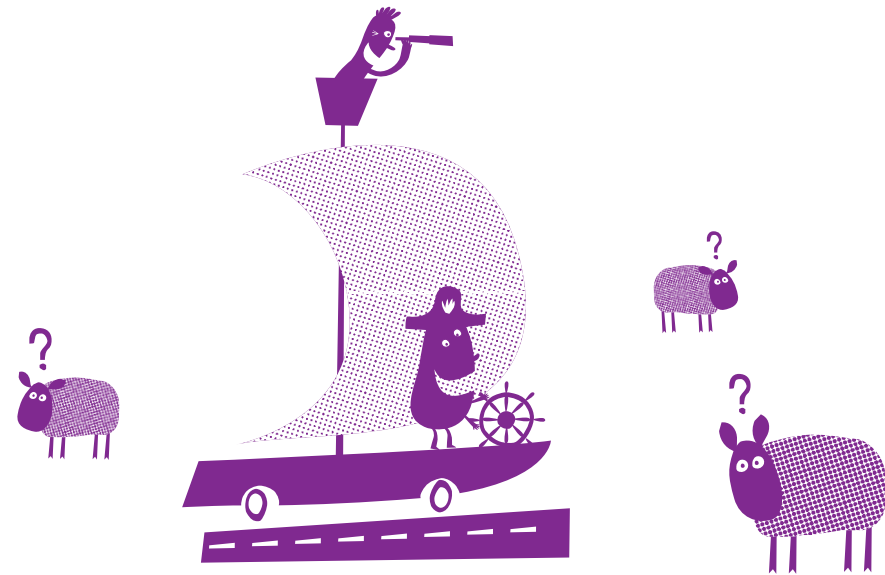

How to

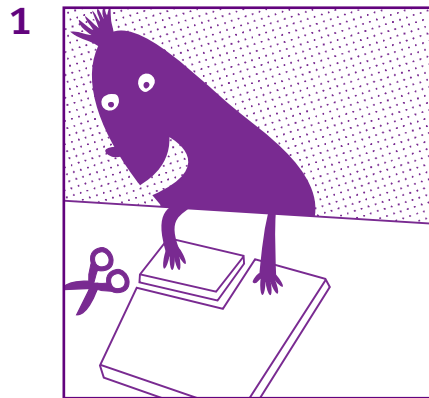

Cut the polystyrene into a rectangle approximately 12cm x 6cm.

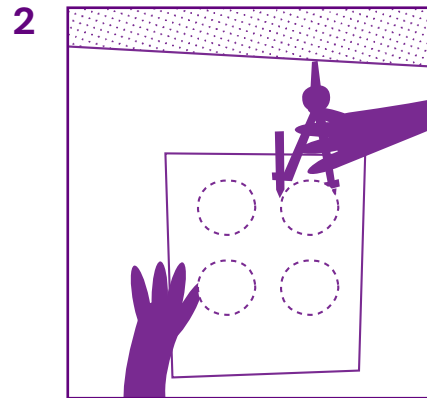

Draw four circles on the cardboard either:

- using a €2 coin
- using a compass with a radius of 1.5cm. The compass method is better as the mark made by compass point tells you where to put the pin in.

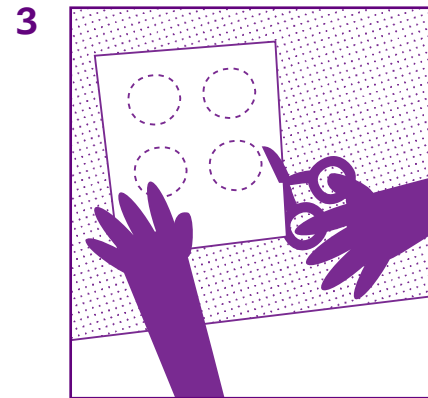

Cut out the circles.

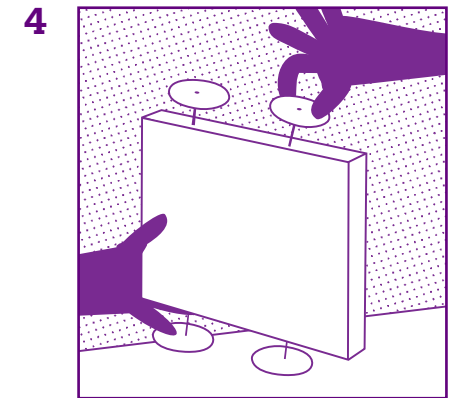

Fix two of the circles to one of the long sides of the polystyrene using pins. Turn the buggy over and fix two wheels on the other long side. Don't push the pins too far into the polystyrene as the wheels may not turn easily: you may need to have a small bead between the wheel and buggy.

How to continued

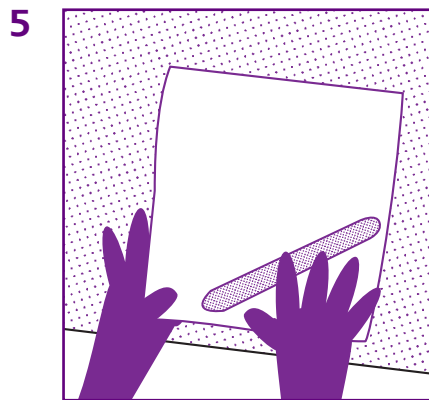
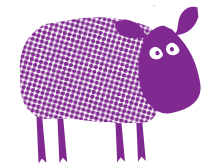

Get a lolly stick and a piece of paper. Cut out a square shape with sides roughly the same length as the stick.

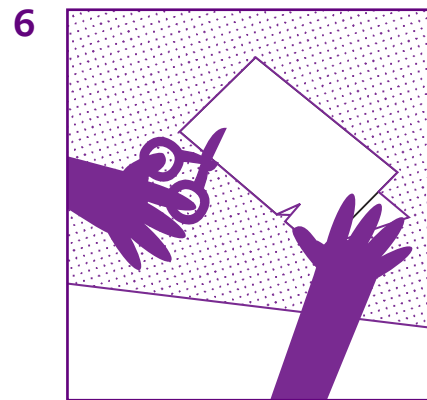

Fold the paper in two, mark the fold 1cm from either end, then make small cuts in the paper.

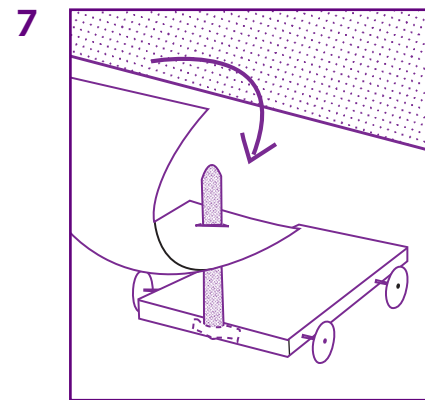

Tape the lolly stick to the front of the buggy. Slide the paper onto the stick by using the small holes made in the paper.

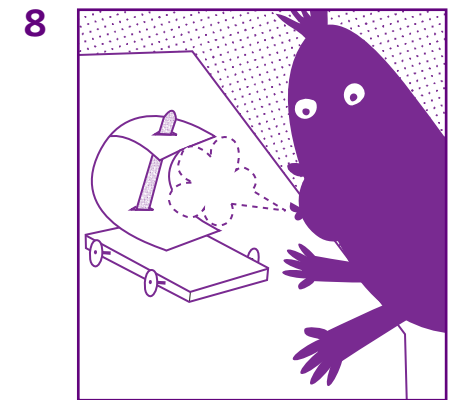

Blow into the sail and watch the land yacht move.